

Track-mounted adjustable spotlights

Strike M is a stylish track-mounted spotlight with discreet in-track control gear and is perfectly suited for display and retail applications. The adaptable design allows interchangeable low glare optics, which are available in either narrow (22°), wide (33°) or flood (54°) beams, providing a smooth distribution and reducing spill light.

Strike M boasts the same great features as the Strike S, including CRI90 LEDs, 3000 K and 4000 K options as standard, and the ability to be rotated 350° azimuth and 90° vertically for a full range of movement. For use with the Track system.

Applications: Display & feature, retail, reception areas, hospitality, art galleries, museums, libraries

- Die-cast aluminium body
- 350° azimuth adjustment
- 90° vertical adjustment
- Low glare optical control
- Optimised beam distribution using lens for reduced spill light
- Fitted with CRI 90 LEDs, suitable for retail applications
- Suitable for installation into Global track



IP20

Up to 123.1 LL/CW

Specification

Mounting	Track	IP rating	IP20
----------	-------	-----------	------

Lighting

Lumen output	1,900 lm - 3,200 lm	Efficacy	Up to 123.1 LL/CW
--------------	---------------------	----------	-------------------

Power

LED power	15 W - 22 W	Circuit power	18 W - 26 W
-----------	-------------	---------------	-------------

LED characteristics

CRI	90+	Colour temperature	3000 K 4000 K
Rated life (hours)	67 K - L80/B10		

Compliance

UKCA	Yes	CE	Yes
------	-----	----	-----

Dimensions

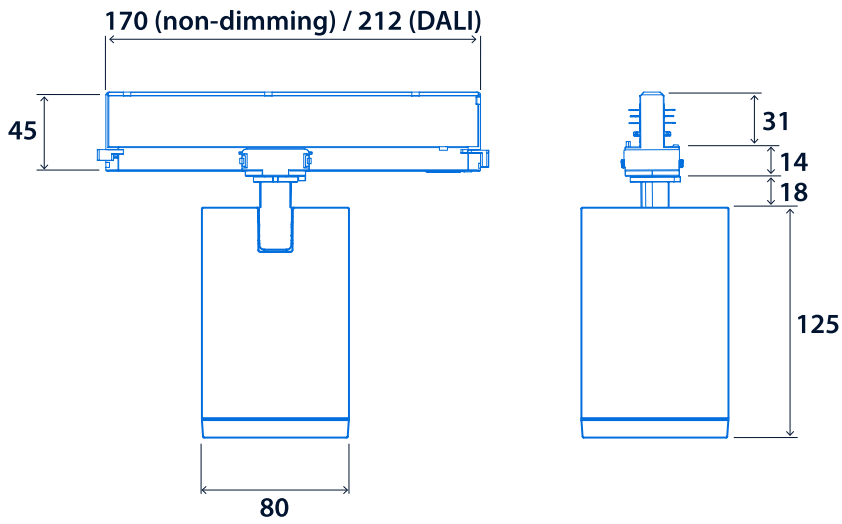

Track mounted non-dimming in white



Track mounted DALI dimming in black



Narrow optic - 22° beam



Wide optic - 33° beam



Flood optic - 54° beam



Click or scan here

View Strike M variants using
our online filtering tool



Information is correct as of 14 Mar 2025, however must not be interpreted as a guarantee of individual product performance and/or characteristics. We reserve the right to alter specifications and designs without prior notice.