

Circular anti-ligature surface LED luminaires

Circular surface anti-ligature and impact-resistant luminaires. Satin polycarbonate cover secured via spun aluminium bezel using tamper-resistant pin Torx screws.

- Strong high-pressure die-cast LM2 aluminium body and cover frame
- High efficiency fire-retardant satin polycarbonate diffuser
- SmartScan wireless technology removes the need for control cabling. Ideal for retro-fit



IP66
IK10
103.5 LL/CW
SMARTSCAN
LUXGUARD

Specification

Mounting	Surface	IP rating	IP66
Impact rating	IK10	Max presence detection height	4 m

Lighting

Optic	Satin diffuser	Lumen output	2,070 lm
Efficacy	103.5 LL/CW		

Emergency data

Emergency lumen output	290 lm	Emergency type	Maintained
Emergency duration	3 hours	Battery specification	Nickel Metal Hydride (NiMH)

Power

LED power	16 W	Circuit power	20 W
-----------	------	---------------	------

LED characteristics

CRI	80+	Colour temperature	4000 K
Rated life (hours)	100 K - L80/B10		

Compliance

UKCA	Yes	CE	Yes
Energy efficiency class	This product contains a light source of energy efficiency class B		

Dimensions

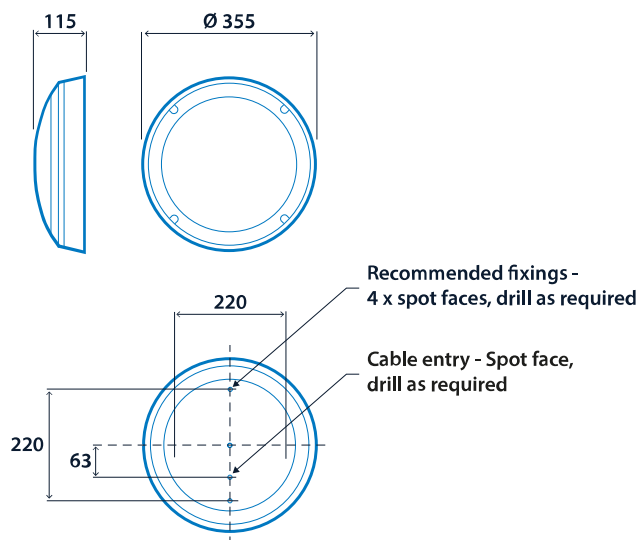



Click or scan here

View Cobalt AL variants using
our online filtering tool



Information is correct as of 22 Feb 2025, however must not be interpreted as a guarantee of individual product performance and/or characteristics. We reserve the right to alter specifications and designs without prior notice.