

Wall mounted LED uplighters

The smallest member of the Clara family, the Clara 90, provides a compact and elegant lighting solution. The Clara 90 uses 10 high powered LEDs mounted onto a special aluminium clad heat sinking circuit board, it has an integral LED driver and a dimming version. Please also see Clara 180 and Clara 360.

Applications: corridors, stairwells, reception areas, meeting rooms, pillars in open plan offices.

- Compact and elegant lighting solution



IP40
Up to 96.7 LL/CW
LED PROTECT

Specification

Mounting	Surface	IP rating	IP40
----------	---------	-----------	------

Lighting

Optic	Clear cover	Lumen output	1,160 lm - 2,020 lm
Efficacy	Up to 96.7 LL/CW		

Power

LED power	10 W - 20 W	Circuit power	12 W - 23 W
-----------	-------------	---------------	-------------

LED characteristics

CRI	80+	Colour temperature	4000 K
Rated life (hours)	100 K - L90/B10		

Compliance

UKCA Yes CE Yes

Energy efficiency class This product contains a light source of energy efficiency class C

Dimensions

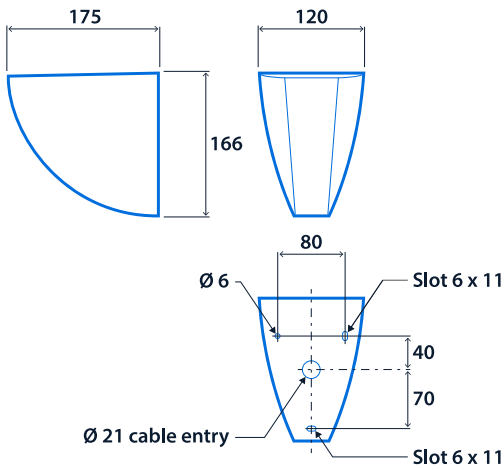

Click or scan here
View Clara 90 variants using
our online filtering tool



Information is correct as of 22 Feb 2025, however must not be interpreted as a guarantee of individual product performance and/or characteristics. We reserve the right to alter specifications and designs without prior notice.