

Track-mounted adjustable spotlights

Strike S is a stylish track-mounted luminaire with discreet in-track control gear and is the smallest in the Strike spotlight range. The low glare optics provide a smooth distribution and are available in either narrow (26°), wide (37°) or flood (53°) beams.

Supplied with CRI 90 LEDs for excellent colour quality, in either 3000 K or 4000 K as standard. Rotatable through 350° azimuth and 90° vertically for a full range of movement makes Strike S a versatile lighting option for the space. For use with the Track system.

Applications: Display & feature, retail, reception areas, hospitality, art galleries, museums, libraries

- Die-cast aluminium body
- 350° azimuth adjustment
- 90° vertical adjustment
- Low glare optical control
- Optimised beam distribution using lens for reduced spill light
- Fitted with CRI 90 LEDs, suitable for retail applications
- Suitable for installation into Global track



IP20

Up to 123.1 LL/CW

Specification

Mounting	Track	IP rating	IP20
----------	-------	-----------	------

Lighting

Lumen output	900 lm - 2,225 lm	Efficacy	Up to 123.1 LL/CW
--------------	-------------------	----------	-------------------

Power

LED power	6 W - 17 W	Circuit power	8 W - 20 W
-----------	------------	---------------	------------

LED characteristics

CRI	90+	Colour temperature	3000 K 4000 K
Rated life (hours)	67 K - L80/B10		

Compliance

UKCA	Yes	CE	Yes
------	-----	----	-----

Dimensions

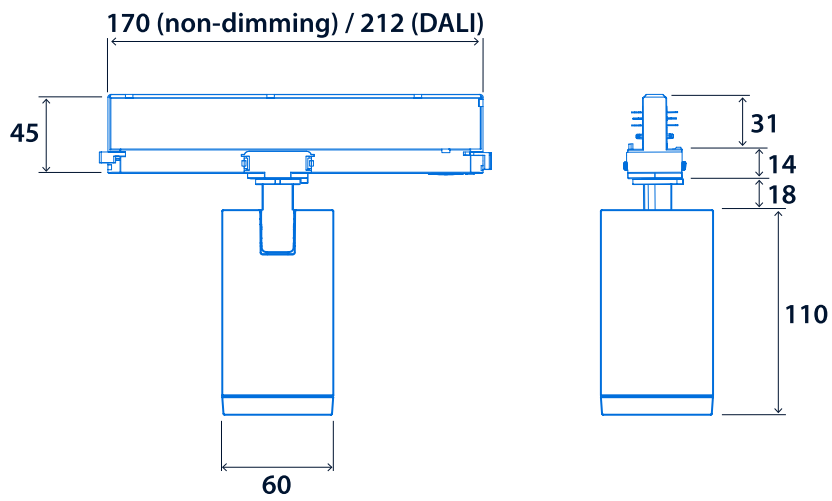

Track mounted non-dimming in white



Track mounted DALI dimming in black



Narrow optic - 26° beam



Wide optic - 37° beam



Flood optic - 53° beam

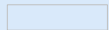

Click or scan here
View Strike S variants using
our online filtering tool



Information is correct as of 12 Mar 2025, however must not be interpreted as a guarantee of individual product performance and/or characteristics. We reserve the right to alter specifications and designs without prior notice.